

VİZYON

Hasta ve hastanelerle sürekli iletişim halinde mevcut ürünleri geliştirmek, kullanıcı ihtiyaçlarını göz önünde bulundurup çeşitlilik ve kaliteyi artırmak, hasta sağlığı güvenliğini ve memnuniyetini artırmak, ihracat yaparak ülke ekonomisine katkıda bulunmak.

Developing existing products in constant communication with patients and hospitals, taking into account user needs to increase diversity and quality, to increase patient health safety and satisfaction, to import and to contribute to the country's economy by exporting.

MİSYON

Medikal sektörünün ihtiyaçları doğrultusunda en son teknolojiler ile medikal cihazlar üreterek tüm dünyaya ulaşmasını sağlıyoruz. Yurtiçi ve yurtdışı güvenilirlik, yenilikçilik ve kalite konusunda özen gösteren 30 yıllık markayız.

We produce medical devices with the latest technologies in line with the needs of the medical sector and ensure that they reach all over the world. We are a 30-year-old brand that pays attention to domestic and international reliability, innovation and quality.

1

Onno Ameliyat Masası
// Onno Operation Table

2

Yarı Elektrikli Ameliyat Masası
// Semi Electrical Operation Table

3

Radyoloji Masası / Algoloji Masası
// Radiology Table/Algology Table

4

Ameliyat Masası Sarf Malzemeleri
// Operation Table Consumables

5

Çift Başlıklı Ameliyat Lambası
// Double Head Operation Lights

6

Ameliyat Lambaları
// Operation Lights

Tek Başlıklı Ameliyat Lambası
// Single Head Operation Lights

7

Tek Başlıklı Ameliyat Lambası
// Single Head Operation Light

Duvara Monte Ameliyat Lambası
// Wall-Mounted Operation Light

8

Mobil Ameliyat Lambası
// Mobile Operation Light

9

Mobil LED Muayene Lambası
// Mobile LED Examination Light

10

LED Fototerapi
// LED Phototherapy

Bebek Kot Yatağı
// Baby Cot

11

Video Kolposkop Cihazı
// Video Colposcope Device

12

Elektrokoter Cihazları
// Electrocautery Devices

13

Ahşap/Elektrikli Muayene Sedyesi
// Wood/Electrical Examination Stretcher

14

Jinekoloji Masası
// Gynecology Table

15

Jinekoloji Muayene Seti
// Gynecology Examination Set

16

Doğum Masası
// Obstetric Table

17

Doğum Masası Seti
// Obstetric Table Set

18

Crash Cart
// Crash Cart

19

Crash Cart
// Crash Cart

20

Tıbbi Cihaz Sehpaları
// Medical Device Trolleys

21

Ultrason Sehpaları
// Ultrasound Trolleys

Tıbbi Cihaz Sehpaları
// Medical Device Trolleys

22

Paslanmaz Ameliyathane Dolapları
// Stainless Operation Room Cabinets

23

Ameliyathane Paslanmaz Ürünleri
// Operation Room Stainless Products

24

Aşı Dolapları
// Vaccine Cabinets

25

Acil Müdahale Sedyesi
// Emergency Action Stretcher

Ameliyathane Transfer Sedyesi
// Operation Room Transfer Stretcher

26

Küvöz Sarf Malzemeleri
// Incubator Consumables

27

Sarf Malzemeler
// Consumables



- Trendelenburg: 25°
- Lateral Tilt: $\pm 20^\circ$
- Sirt Kısmı (Back Section): $\pm 60^\circ$
- Baş Kısmı (Head Section): $\pm 60^\circ$
- Bacak Kısmı (Leg Section): 0°-90°
- Zemin Kilit Sistem (Floor Lock System): Uzaktan (Remote)
- Sıfırlama Modu - Zero Mode
- Uzunluk (Length) : 1900 mm
- Genişlik (Width) : 520 mm
- Min. Yükseklik (Min. Height) : 750 mm
- Maks. Yükseklik (Max Height) : 1000 mm



Yarı Elektrikli Ameliyat Masası // Semi Electrical Operation Table



- Uzunluk (Length) : 1900 mm
- Genişlik (Width) : 520 mm
- Min. Yükseklik (Min.Height) : 750 mm
- Max.Yükseklik (Max.Height) : 1000 mm
- Trendelenburg : 25°
- Lateral Tilt : ±20°
- Sırt Kısmı (Back Section) : ±60°
- Baş Kısmı (Head Section) : ±60°
- Bacak Kısmı (Leg Section) : 0°-90°
- Zemin Kilit Sistem (Floor Lock System) : Manuel

Göz Operasyon Masası // Ophthalmic Operation Table

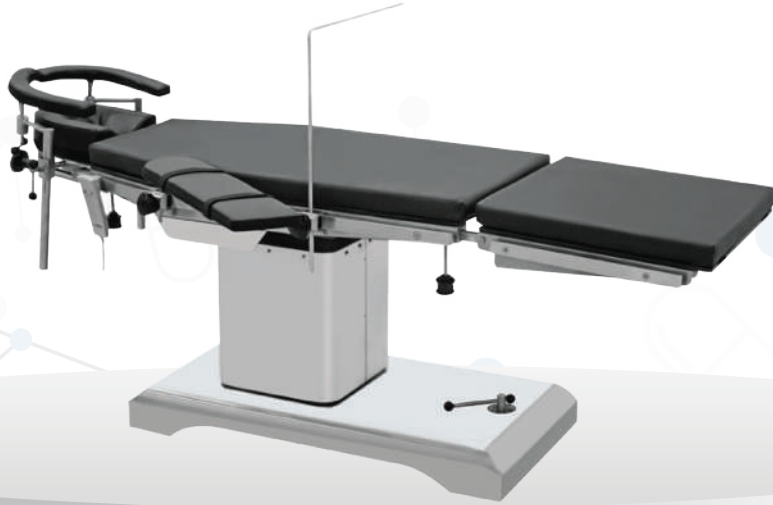

- Uzunluk (Length) : 1915 mm
- Genişlik (Width) : 520 mm
- Min.Yükseklik (Min Height) : 750 mm
- Max.Yükseklik (Max Height) : 1000 mm
- Bacak Kısmı (Leg Section) : 0°-90°

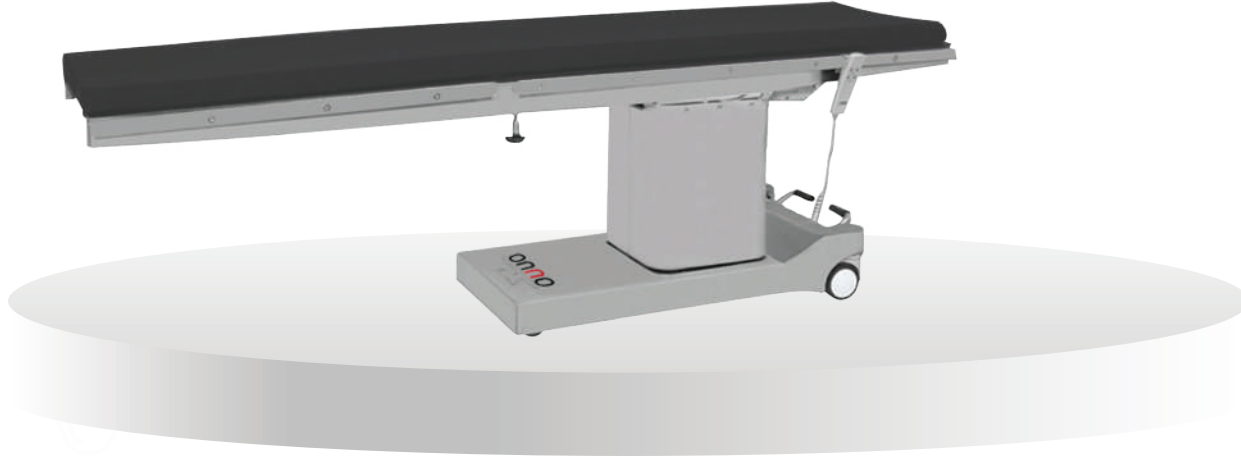

- Kablolu uzaktan kumanda
- Sütunda elektrik fonksiyonları için renkli ek işletim paneli
- X ve scopi ışınları geçirir
- Aksesuarların eklenmesi için SS 304'den yapılmış yan raylı masaüstü
- Baş dayanağı sistemlerin sabitlenmesi için karbon fiberden yapılmış ön-yan raylar
- Boyuna kaydırmalı masa tablası
- 50 mm kalınlığında şilte
- Wire remote control
- Additional operating panel with color display for electrical functions in the column
- Transmits X and scopi rays
- Table top with side rails made of SS 304 for adding accessories
- Front side rails made of carbon fiber for fixing headrest system
- Longitudinal slide top
- 50 mm thick mattress

Algoloji Masası // Algology Table



- Uzunluk (Lenght) : 1915 mm
- Genişlik (Widht) : 520 mm
- Min.Yükseklik (Min Height) : 750 mm
- Max.Yükseklik (Max Height) : 1000 mm
- Bacak Kısmı (Leg Section) : 0°-90°

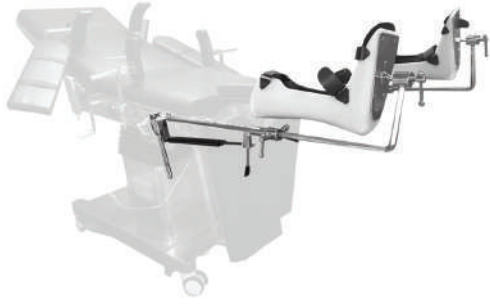

Bariatrik Sistem // Bariatric System

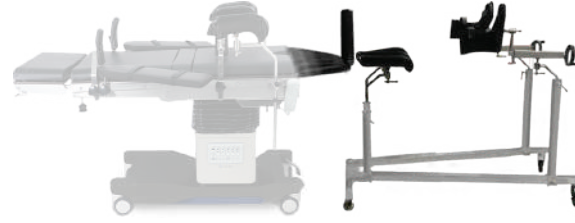

Ortopedik Traksiyon Ünitesi // Orthopedic Traction Unit



Omuz Artroskopisi Atançmanı
// Shoulder Arthroscopy Attachment



Genişletme Aparatı // Extension Attachment



Beyin Ameliyat Aparatı
// Brain Surgery Attachment



Göz Operasyon Atançmanı
// Ophthalmic Operation Attachment



Kol Destek Aparatı // Arm Rest Attachment



Anestezi Siperliği // Anaesthesia Screen

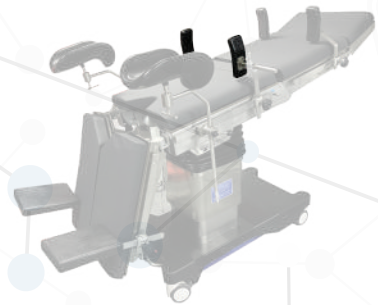

Yan Destek Aparatı
// Operating Table Side Support



Omuz Destek Atançmanı
// Shoulder Rest Attachment



Proktoloji Destek Aparatı // Proctology Attachment



Jinekoloji Destek Aparatı
// Operating gynecological Support



- Parlaklık Kontrolü : Kapasitif Dokunmatik Panel
 - Odaklanma : Ayarlanabilir
 - Renk Sıcaklığı : 4000-5000K
 - Renk Azaltma İndeksi : 93 RA
 - LED Rengi : Beyaz&Sarı Çift Renk
 - Yoğunluk : 160000 +160000 Lux + 10%
 - LED Ömrü : >50000 Saat (Hrs.)
 - LED Sayısı : 126+126
 - Işık Çapı : 500 mm x2
 - Işık Alanı : 12-30 cm
 - Güç Kaynağı : 220V / 50Hz AC
- Brightness Control : Capacitive touch panel
 - Focus : Adjustable
 - Color Temperature : 4000-5000K
 - Color Reduction Index : 93 RA
 - Color LED : White&Yellow Double color
 - Intensity : 160000 +160000 Lux + 10%
 - LED Life : >50000 Saat (Hrs.)
 - Number of LED : 126+126
 - Diameter of Light : 500 mm x2
 - Size of Light Field : 12-30 cm
 - Power Supply : 220V / 50Hz AC

- Yoğunluk : 40000-170000
- Işık Alanı : 300 mm
- Renk Sıcaklığı : 4300+500K
- Aydınlatma Alanı : 600 mm
- Renk İndeksi : 95
- LED Ömrü : >5000 Saat
- Illumination : 40000-170000
- Focusable Light Size : 300 mm
- Color Temperature : 4300+500K
- Field of Lights : 600 mm
- Color Index : 95
- LED Life : >5000h

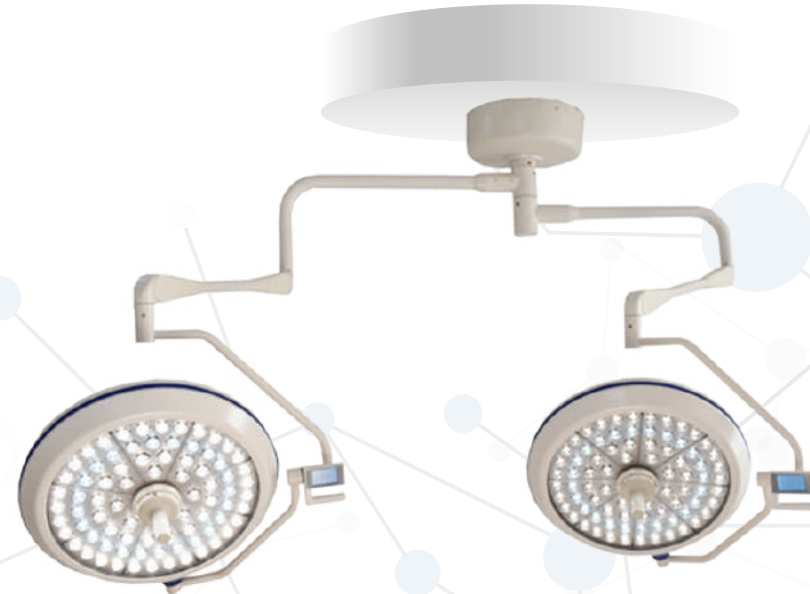

Ameliyat Lambaları // Operation Lights

- Yoğunluk : 150.000 + 150.000 Lux + %10
 - LED Ömrü : >50.000 Saat
 - LED Sayısı : 84 + 84
 - Işık Çapı : 500 mm x2
 - Işık Alanı : 12-30 cm
 - Güç Kaynağı : 220V / 50Hz AC
 - Parlaklık Kontrolü : Kapasitif Dokunmatik Paneli
 - Odaklanma : Ayarlanabilir
 - Renk Sıcaklığı : 4000-5000K
 - LED Rengi : Beyaz-Sarı Çift Renk
-
- Intensity : 150.000 + 150.000 Lux 10%
 - LED Life : >50.000 Hrs.
 - Number of LED : 84+84
 - Size of Light Field : 12-30 cm
 - Power Supply : 220V / 50Hz AC
 - Brightness Control : Capacitive touch panel
 - Focusing : Adjustable
 - Color Temperature : 4000-5000K
 - Color Of LED : White & Yellow Double Color

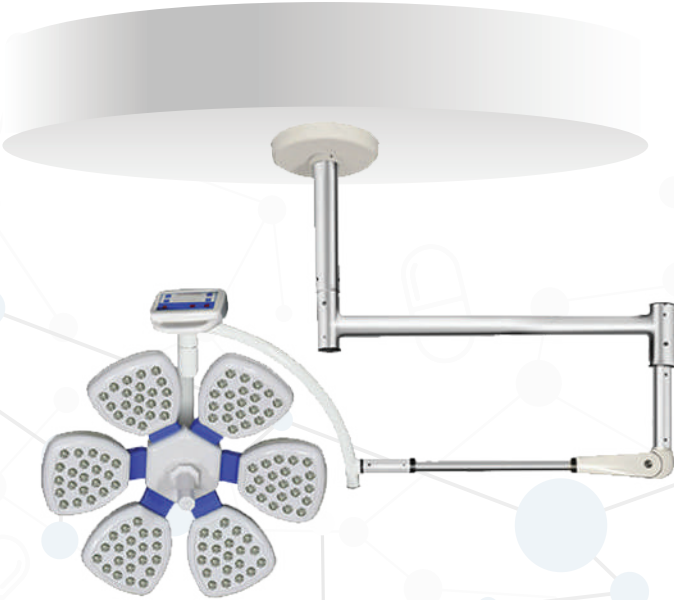

Tek Başlıklı Ameliyat Lambaları // Led Operation Lights

- Parlaklık Kontrolü (Brightness control) : Kapasitif Dokunmatik Panel (Capacitive touch panel)
 - Odaklanma (Focusing) : Ayarlanabilir (Adjustable)
 - Renk Sıcaklığı (Color temperature) : 4000-5000K
 - Renk Azaltma İndeksi (Color reduction index) : 93 RA
 - LED Rengi (Color of led) : Beyaz&Sarı Çift Renk (White&Yellow) Double Color
-
- Yoğunluk (Intensity) : 160.000 + 160.000 Lux +10%
 - LED Ömrü (Led Life) : >50.000 Hrs.
 - LED Sayısı (Number of LED) : 126
 - Işık Çapı (Diameter of Light) : 600 mm
 - Işık Alanı (Size of Light Field) 12-30 cm
 - Güç Kaynağı (Power Supply) : 220V / 50Hz AC

Tek Başlıklı Ameliyat Lambaları // Single Head Operation Lights

- **Parlaklık Kontrolü : Kapasitif Dokunmatik Panel** Brightness Control : Capacitive Touch Panel
- **Odaklanma : Sabit** Focus : Fixed
- **Renk Sıcaklığı : 4500K** Color Temperature : 4500K
- **Renk Azaltma : 93 RA** Color Reduction Index : 93 RA
- **LED Rengi : Beyaz** Color of LED : White
- **Yoğunluk : 80.000 Lux + %10** Intensity : 80.000 Lux +10%
- **LED Ömrü : >50.000 Saat** LED Life : >50.000 Hrs.
- **LED Sayısı : 28** Number of LED : 28
- **Işık Çapı : 200 mm** Diameter of Light : 200 mm
- **Işık Alanı : 15 cm** Size of Light Field : 15 cm
- **Güç Kaynağı : 220V / 50Hz AC** Power Supply : 220V / 50Hz AC



Duvara Monte Ameliyat Lambası // Wall-Mounted Operation Light

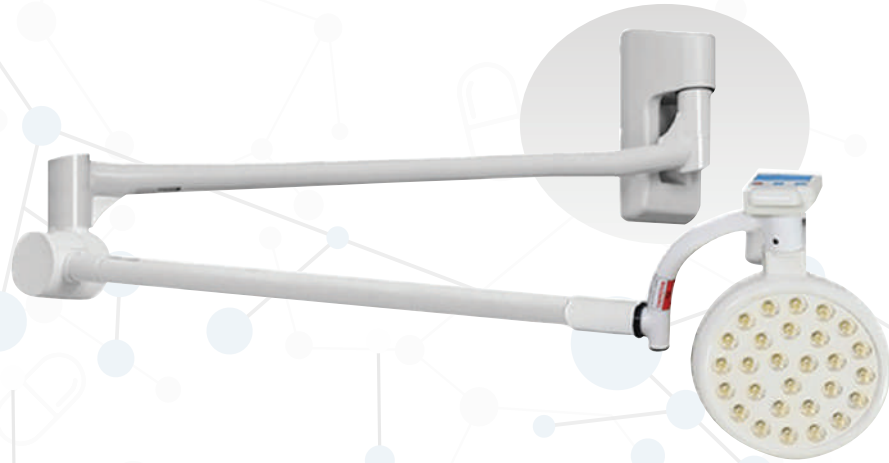

- **Parlaklık Kontrolü : Kapasitif Dokunmatik Panel** Brightness Control : Capacitive Touch Panel
- **Odaklanma : Sabit** Focus : Fixed
- **Renk Sıcaklığı : 4500K** Color Temperature : 4500K
- **Renk Azaltma : 93 RA** Color Reduction Index : 93 RA
- **LED Rengi : Beyaz** Color of LED : White
- **Yoğunluk : 80.000 Lux + %10** Intensity : 80.000 Lux +10%
- **LED Ömrü : >50.000 Saat** LED Life : >50.000 Hrs.
- **LED Sayısı : 28** Number of LED : 28
- **Işık Çapı : 200 mm** Diameter of Light : 200 mm
- **Işık Alanı : 15 cm** Size of Light Field : 15 cm
- **Güç Kaynağı : 220V / 50Hz AC** Power Supply : 220V / 50Hz AC



- Yoğunluk: 120.000 Lux + %10
- Işık Alanının Boyutu : 12-30 cm
- Renk Sıcaklığı : 4000-5000K
- Renk Azaltma İndeksi : 93 RA
- LED Ömrü : >50.000 Saat
- LED Sayısı : 56
- Işık Çapı : 600
- Intensity : 120.000 + 10%
- Size of Light Field : 12-30 cm
- Color Temperature : 4000-5000K
- Reduction Index : 93 RA
- LED Life : >50.000 Hrs.
- Number of LED : 56
- Diameter of Light : 600

- Parlaklık Kontrolü : Kapasitif Dokunmatik
- Güç Kaynağı : 220V / 50Hz AC
- LED Rengi : Beyaz&Sarı
- Odaklanma : Sabit
- Akü Kullanım Süresi : 4 Saat
- Akü Kapasitesi : 24 Saat
- Brightness: Capacitive Touch Panel
- Power Supply: 220V / 50Hz AC
- LED Color : White&Yellow
- Focus : Fixed
- Battery Lifespan : 4 Hrs.
- Battery Capacity : 24 Hrs.



- Yoğunluk : 55.000 Lux + %10
- Işık Alanının Boyutu : 125 mm
- Renk Sıcaklığı : 4000-5000K
- Renk Azaltma İndeksi : 93 RA
- LED Ömrü : >50.000 Saat
- LED Sayısı : 7
- Işık Çapı : 150 mm
- Güç Kaynağı : 220V / 50Hz AC

- Intensity : 55.000 Lux + 10%
- Size of Light Field : 125 mm
- Color Temperature : 4000-5000K
- Reduction Index : 93 RA
- LED Life : >50.000 Hrs.
- Number of LED : 7
- Diameter of Light : 150 mm
- Power Supply : 220V / 50Hz AC

- Yoğunluk : 30.000 Lux + %10
- Işık Alanının Boyutu : 125 mm
- Renk Sıcaklığı : 4000-5000K
- Renk Azaltma İndeksi : 93 RA
- LED Ömrü : >50.000 Saat

- Intensity : 30.000 Lux + 10%
- Size of Light Field : 125 mm
- Color Temperature : 4000-5000K
- Color Temperature Index : 93 RA
- LED Lifespan : >50.000 Hrs.



- Temizlik için çıkartılabilen bebek tepsi mevcuttur.
- Bebeğin gözlerini kapatmaya gerek yoktur
- Herhangi bir fototerapi sistemine (120W) kıyasla düşük güç tüketimi mevcuttur
- (12W)LED'ler 450-470 nm'de mavi ışık yaymaktadır
- Bilirubinin parçalandığı pik absorpsiyon dalgaboyu yaklaşık 458 nm'dir
- Kızılötesi radyasyon aralığında ışık yaymaz sıvı kaybı riskini azaltır
- Uzun ömürlüdür > 20.000 Saat
- Yoğunluk > 25uW /cm² / nm.M.S.
- Zaman ayarı opsiyoneldir.
- Yükseklik ayarına ve kolay döndürülebilir mekanizmaya sahiptir.
- Çalışma Gerilimi : 100-250V AC, 50Hz

- Detachable baby tray for cleaning
- No need to cover eyes of the baby
- Low power consumption (12W)
- LED's emitting blue light in 450-470 nm
- The peak absorption wavelength at which bilirubin is degraded is approximately 458 nm.
- Do not emit light in infrared radiation range reduction the risk of fluid loss
- Long life >20.000 Hrs.
- Irradiance > 25 uW /cm² / nm.
- Time totalizer (optional)
- Height adjustment and easily rotatable mechanism
- Operation Voltage : 100-250v AC, 50Hz.



Bebek Kot Yatağı // Baby Cot

- Taşıyıcı araba üst kısmına konulan şeffaf pleksiglass kot
- Polikarbondan kot yatağı
- İki kilitlenebilir dört tekerlek
- Transparent plexiglass cot placed on the top of the cart
- Polycarbonate cot bed
- Four wheels, two of them are lockable



- Sony Dijital Renk CCD 800.000 Piksel
 - Beyaz LED ile yüksek parlaklık
 - Geleneksel halojen lambalara göre %60 daha fazla parlaklık ve renk sıcaklığı
 - Yaşam ömrü : 100.000 Saat
 - Daha net resimler için halo filtreleme teknolojisi
 - Ekstra büyük hafıza ile maks. 1 milyon vaka depolanabilir
 - Lens çözünürlüğü . 1/4 HAD renk CCD, 80.000 piksel
 - IENS Eksenel Çözünürlüğü : 470 sıra
 - Lens s/n : 50dB
 - Lens Odaklama Mesafesi : 100-400 mm
 - Tarama alanı : 2.5 mm- 20mm - 320 mm
 - Alan derinliği : 15 mm - 40 mm, 15 mm - 480 mm
-
- Sony Digital Color CCD, 800.000 pixels
 - High brightness with white LED
 - It has 60% more brightness and color temperature than traditional halogen lamps
 - Lifespan: 100.000 Hrs.
 - Halo filtering technology for clear images
 - Can store max. 1 million cases with extra large memory
 - Lens resolution 1/4 HAD color CCD,80.000 pixel
 - Lens axial resolution:100-400 mm
 - Lens s/n : 50dB
 - Lens focusing distance : 100-400 mm
 - Scanning area : 2.5 mm - 20 mm - 320 mm
 - Depth of field : 15 mm - 40 mm, 15 mm - 480 mm





- Kesme ve pıhtılaştırma . 20-100W
- Yakma ve pıhtılaştırma : 20-100W
- Bipolar : 20-100 W
- Çalışma frekansı : 350 kHz
- Beslenme voltajı : 220V / 50Hz
- Boyutları . 250x90x250 mm
- Ağırlık : 3.5 kg



- Cutting and coagulation : 20-100 W
- Combustion and coagulation : 20-100 W
- Operating frequency : 350 kHz
- Supply voltage : 220V / 50Hz
- Dimensions : 250x90x250 mm
- Weight : 3.5 kg



- Sabit ayak, metal konstrüksiyon üzeri MDF
- Havluluk aparatı.
- Yatak dahil en : 650 mm
- Yatak dahil boyu : 1850 mm
- Yatak dahil yüksekliği : 780 mm
- Fixed foot, MDF over metal construction
- Towel holder
- Width including bed : 650mm
- Length including bed : 1850mm
- Height including bed : 780mm



- El kumandası
- 360° dönebilen çapraz fren tekerler
- Aşağı-Yukarı hareket mekanizması
- Hand control
- 360° rotatable cross brake wheel
- Up-down mechanism



- Sırt bölümü elektrikli motor ile ayarlanabilir
 - Ayak bölümü maneldir
 - 0-25° aralığında trendelenburg yapabilmektedir
 - Trendelenburg hareketi elektrikli motor ile ayarlanabilir
 - El kumandası yardımı ile yerden yüksekliği 20 cm artırılabilir veya azaltılabilir
 - El kumandası ile fonksiyonlar kontrol edilebilir
 - Koltuğun yatak platformu dikişsiz olup, kan gibi lekelerin tutunmasına engel olmaktadır
 - Masanın kaldırma kapasitesi 250 kg'dir
- Back section can be adjusted with electrical motor.
 - Foot section is manual.
 - Can do trendelenburg 0-25°
 - Trendelenburg can be adjusted with electrical motor
 - Ground clearance can be increased or decreased by 20 cm with remote controller
 - The bed platform of the chair is seamless and prevents stains such as blood
 - Lifting capacity is 250 kg





Set İçerikleri

- Jinekoloji Masası
- Elektrokoater Cihazı
- Video Kolposkop Cihazı
- Tibbi Cihaz Sehpası
- NST Cihazı
- Ray Tipi Muayene Lambası

Set Content

- Gynecology Table
- Electrocautery Device
- Video Colposcope Device
- Medical Device Trolley
- NST Device
- Rail-Mounted Inspection Light





Maks. 80°
Max. 80°

- El kumandası ile fonksiyonlar kontrol edilebilir
- Koltuğun yatak platformu dikişsiz olup, kan gibi lekelerin tutunmasına engel olmaktadır
- Masanın kaldırma kapasitesi 250 kg'dır

- Functions can be controlled with the remote control
- The bed platform of the chair is seamless and prevents stains such as blood
- The lifting capacity of the table is 250 kg

Ölçüler

- Yükseklik : Min. 57 - Maks. 87 cm
- En : 65 cm
- Sırt Kısmı : 92 cm
- Oturma Kısmı : 58 cm

Dimensions

- Height : Min. 57 - Max. 87 cm
- Weight : 65 cm
- Back Section : 92 cm
- Sitting Place : 58 cm





Set İçerikleri

- Doğum Masası
- Elektrokoter Cihazı
- Video Kolposkop Cihazı
- Tıbbi Cihaz Sehpası
- NST Cihazı
- Ray Tipi Muayene Lambası

Set Content

- Obstetric Table
- Electrocautery Device
- Video Colposcope Device
- Medical Device Trolley
- NST Device
- Rail-Mounted Inspection Light





- Araba darbe ve çarpmalara dayanıklıdır.
- Arabanın 5 çekmecesine vardır.
- Arabanın tüm çekmeceleri teleskopik ray sistemi ile çalışmaktadır.

- It is resistant to impacts and bumps.
- Cart has 5 shelves.
- All cart shelves work with telescopic rails.



- Arabanın iki tane frenli olmak üzere dört tekerleği mevcuttur.
- Üründe çöp aparatı mevcuttur. (opsiyonel)
- Üstünde ilaç aparatı mevcuttur, 2 sıra 6-6 toplam 12 adet ilaç kutusu mevcuttur. (opsiyonel)

- Cart has 4 castors, 2 of them with brake.
- Product has trash addition (optional).
- Medicine addition on top of the cart, 2 line 6-6, at total 12 medicine box available (optional).

- **Büyük Boy Acil Müdahale ve Pansuman Arabası Ölçüleri // Large Emergency Cart Dimensions:**
En (Width): 80 cm - Boy (Height): 110 cm - Derinlik (Depth): 55 cm
- **Büyük Boy İlaç Hazırlama Arabası Ölçüleri // Large Anesthesia Cart Dimensions:**
En (Width): 80 cm - Boy (Height): 155 cm - Derinlik (Depth): 55 cm
- **Küçük Boy Acil Müdahale ve Pansuman Arabası Ölçüleri // Small Emergency Cart Dimensions:**
En (Width): 68 cm - Boy (Height): 105 cm - Derinlik (Depth): 55 cm
- **Küçük Boy İlaç Hazırlama Arabası // Small Anesthesia Cart Dimensions:**
En (Width): 68 cm - Boy (Height): 105 cm - Derinlik (Depth): 55 cm



- Araba darbe ve çarpmalara dayanıklıdır.
- Arabanın beş çekmecesine vardır.
- Arabanın tüm çekmeceleri teleskopik ray sistemi ile çalışmaktadır.
- It is resistant to impacts and bumps.
- Cart has 5 shelves.
- All cart shelves work with telescopic rails.

- Arabanın iki tane frenli olmak üzere dört tekerleği mevcuttur.
- Üründe çöp aparatı mevcuttur. (opsiyonel)
- Üstünde ilaç aparatı mevcuttur, 2 sıra 6-6 toplam 12 adet ilaç kutusu mevcuttur. (opsiyonel)
- Cart has 4 castors, 2 of them with brake.
- Product has trash addition (optional).
- Medicine addition on top of the cart, 2 line 6-6, at total 12 medicine box available (optional).



- 2 Frenli 2 frensiz olmak üzere 4 tekerleği mevcuttur.
- Aksesuar sepeti mevcuttur.
- Tıbbi cihazlar için tasarlanmıştır.
- It has 4 wheels, 2 with brakes .
- Has an accessory basket.
- Designed for medical devices.



- 2 Frenli 2 frensiz olmak üzere 4 tekerleği mevcuttur.
- Prop asma ve takma aparatı
- Ultrason yazıcı bölmesi

- It has 4 wheels, 2 with brakes.
- Prop hanging and attaching apparatus.
- Ultrasound printer compartment.



- Tekerlekleri sayesinde taşınması kolaydır.
- Korozyona karşı dayanıklı malzemeden üretilmiştir.
- İki tanesi frenli olmak üzere dört adet tekerleği vardır.
- 1 veya 3 adet çekmece ve 2 adet rafı vardır.

- Easy to move thanks to it is wheels.
- Made of corrosion resistant material
- Four wheels, two with brakes.
- There are 1 or 3 drawer and 2 shelves



Serum Askılığı
// IV Stand



Paslanmaz Serum Askılığı
// Stainless IV Stand



Paslanmaz Ameliyathane Dolapları // Stainless Surgery Cabinets

1 Paslanmaz Ameliyathane Dolabı // Stainless Surgery Cabinet

- Ameliyathane ve müdahale odaları için 304 kalite paslanmaz çelik üretim
- Kilitlenebilir temperlenmiş camdan kapaklar
- Ayarlanabilir 3 adet raf
- Kolay açılıp kapanan tamamı paslanmaz çelik dört adet çekmece
- Zemin dengesini sağlayan 4 adet rotil ayak
- 304 quality stainless steel production for operation rooms and intervention rooms
- Lockable tempered glass doors
- 3 adjustable shelves
- Four easy-to-open all stainless steel drawers
- 4 ball joint feet providing ground balance

2 Paslanmaz Çekmeceli Ameliyathane Dolabı // Stainless Surgery Cabinet with Drawer

- Ameliyathane ve müdahale odalarında kullanılmak üzere tasarlanmıştır.
- Dolapta 3 adet rafla bölünmüş 4 adet istifleme alanı mevcuttur.
- İki taraflı açılabilen kapak mevcuttur.
- 304 kalite paslanmaz çelikten üretilmiştir.
- Zemine göre dolabın yüksekliğini ve terazisini ayarlamaya yarayan 4 adet ayak bulunmaktadır.
- It designed to be used in operating rooms and intervention rooms.
- There are 4 stacking areas in the cabinet, divided by 3 shelves.
- There is a cover that can be opened from both sides.
- Made of 304 quality stainless steel
- There are 4 feet to adjust the height and scale of the cabinet according to the floor.

3 Paslanmaz Endoskopi Dolabı // Stainless Endoscopy Cabinet

- Steril olması gereken tüm klinik-poliklinik ortamlarda kullanılmak üzere tasarlanmıştır
- 304 Kalite paslanmaz çelikten üretilmiştir
- Cihazlara zarar vermeyecek özel tasarım pleksiglass dört adet tutma aparatı vardır
- Kompozit veya pleksi malzemeden raylı sistem ile 3/2 oranında dışarı çıkan endoskop asma bölümü mevcuttur
- Su toplama tepsi, havalandırma mazgalı bulunmaktadır
- İç yüzeyler yumuşak vinil kaplıdır
- Ebatlar : 210 x 60 x 37 cm
- It is designed to be used in all clinic-polyclinic environments that need to be sterile
- Made of 304 quality stainless steel
- Four plexglass holding apparatus is specially designed to prevent damage
- Endoscope hanging part that comes out 3/2 ratio with a rail system made of composite or plexi material
- Water collecting tray, ventilation grille
- Inner surfaces are covered with soft vinyl
- Dimensions: 210 x 60 x 37 cm





• Ay Masa // Moon Table



• Soğutuculu Alet Masası
// Instrument Table with Freezer



• Alet Masası // Instrument Table



• Hidrolik Mayo Masası
// Hydraulic Mayo Table



• Mekanik Mayo Masası
// Mechanical Mayo Table



• Evye // Sink

Özellikler

- 304 kalite paslanmaz çelik.
- Hidrolik ayak pompası ile yükseklik ayarı ayarlanabilir.
- 3 tekerlekli.

Specifications

- 304 quality stainless steel
- Height adjustment with hydraulic foot pump
- 3 wheels

Boyutlar

- 50 x 70 x 78/123 mm.
- Hidrolik yükseklik ayarı (ExBxY) 50 x 70 x 78/123 mm
- Mekanik yükseklik ayarı (ExBxY) 50 x 70 x 78/123 mm
- Dimensions (WxLxH)
- Hydraulic height adjustment (WxLxH) 50X70X78/123
- Mechanical height adjustment (WxLxH) 50X70X78/123

- Steril olması gereken tüm klinik-poliklinik ortamlarda kullanılır.
- AISI 304 Stainles Steel'den yapılmıştır
- Fotoselli ve diz kontrollü, su ve sabun akış sistemi vardır.

- Used in all clinical-policalinical environments that need to be sterile.
- Made of AISI 304 Stainless Steel
- There is a photocell and knee-controlled water and soap flow system.



- **Korozyon önleyici toz boyalı çelik dış gövde**
 - **Yalıtım için yüksek yoğunluklu poliüretan**
 - **Manyetik conta ile çift camlı alüminyum kapı**
 - **0,1°C hassasiyetle sıcaklık ölçüm hassasiyeti**
 - **Kilitlenebilir kapılar**
 - **Özel raf tasarımı ile maksimum hava sirkülasyonu**
 - **Konum ayarlı raflar**
 - **Buz çözme özelliği**
 - **Kapı açık (prob) arızaları için yüksek sıcaklık, düşük sıcaklık ve sesli alarm sistemi**
 - **Ekstra harici prob girişi (isteğe bağlı)**
 - **Frenli döner tekerlekler sayesinde kolay hareket ettirilebilir**
- Anti corrosive powder painted steel outer body
 - High density polyurethane for insulation
 - Temperature measurement accuracy with the precision of 0,1°C
 - Lockable doors
 - Maximum air circulation with special shelf design
 - Position adjustable shelves
 - Defrosting feature
 - High temperature, low temperature and audible alarm system for door open (prob) faults
 - Easy to move by rotatable castors with breaks



- Yükseklik : 60 - 93 cm
- Trendelenburg: 14°
- Ters Trendelenburg: 14°
- Sırt Kısmı: 63
- Uzunluk: 221 cm
- Genişlik: 80 cm
- Yüzey Uzunluğu: 190 cm
- Teker Çapı: 20 cm
- Çalışma Kapasitesi: 200 kg

- Height: 60 - 93 cm
- Trendelenburg: 14°
- Reverse Trendelenburg: 14°
- Backrest: 63
- Length: 221 cm
- Width: 80 cm
- Surface Length: 190 cm
- Wheel Diameter: 20 cm
- Working Capacity: 200 kg



- Yükseklik (Height): 62 cm
- Yatakla Birlikte Yükseklik (Height with bed): 82 cm
- Trendelenburg: 15°
- Sırt Kısmı (Back section): 0-60
- Uzunluk (Length): 208,5 cm
- İki Araba Uzunluk (Two cars length): 399 cm
- Genişlik (Width): 74 cm
- Yatak Yüzey Uzunluğu (Bed surface length): 185 cm
- Yatak Yüzey Genişliği (Bed surface width): 60 cm
- Sırt Kısmı Uzunluğu (Back section length): 72,5 cm
- Teker Çapı (Wheel diameter): 150 mm
- Güvenli Çalışma Kapasitesi (Safe working capacity): 200 kg

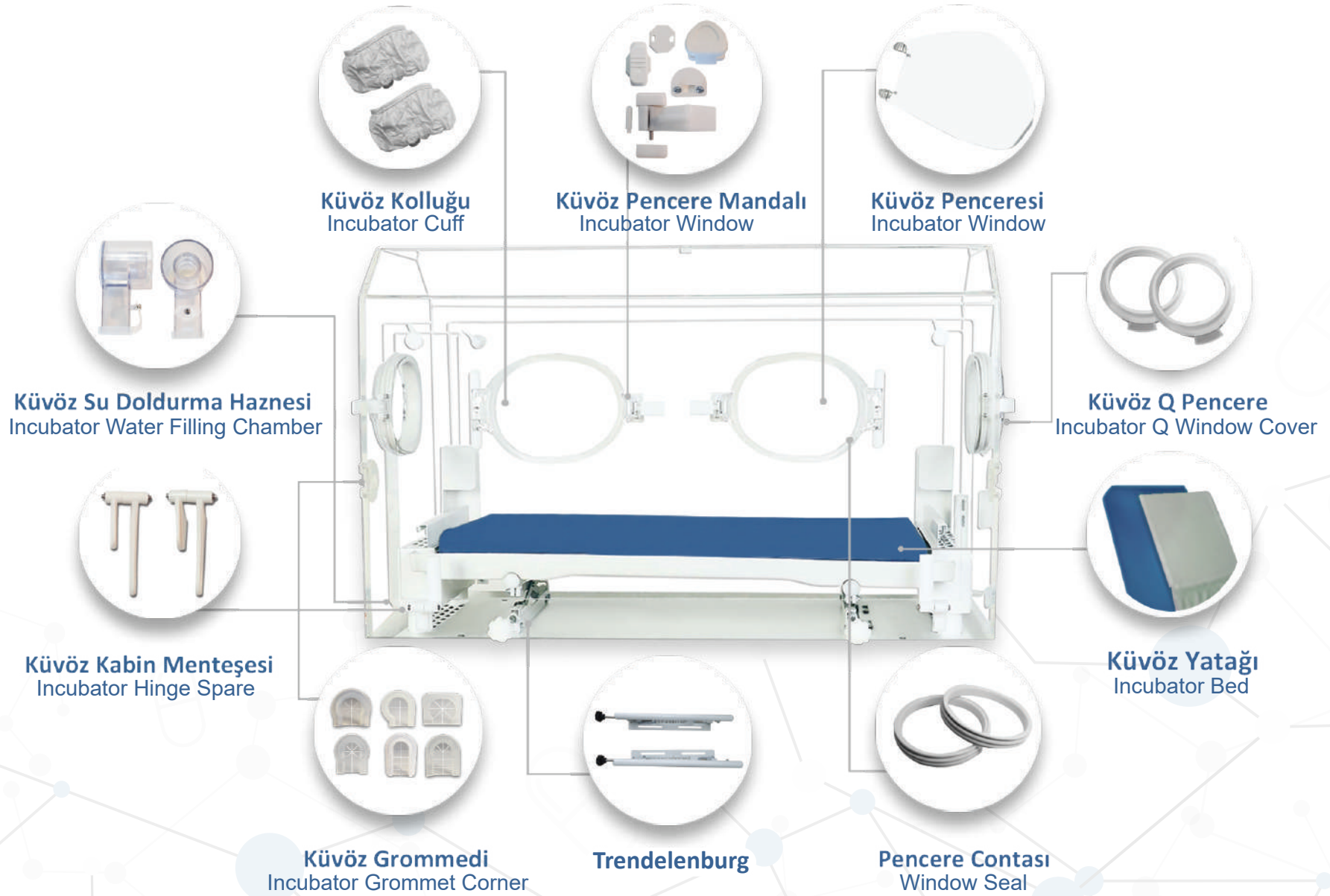



Ekg Puar Mandal Takımı
// Puar Latch Kit



Nebulizator Kristali
// Nebulizer Crystals



NST Kemer
// Fetal Monitor Belt



Cilt Isı Prop
// Skin Temperature Probes



**Büyük Boy (26 cm)
Oksijen Hood Başlığı**
// Large (26 cm)
Oxygen Hood



Su Tutucu
// Water Trap

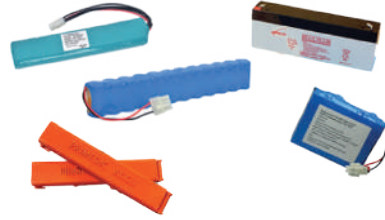

Tıbbi Cihaz Bataryaları
// Medical Equipments Battery



Ventilatör Akış Sensörleri
// Ventilator Flow Sensors



Ventilatör Devre Tutucu
// Ventilator Circuit Holder



**Orta Boy (24 cm)
Oksijen Hood Başlığı**
// Medium (24 cm)
Oxygen Hood



SpO2 Parmak Probu
// SpO2 Finger Probe



EKG Kabloları
// ECG Cables



Tansiyon Manşon Çeşitleri
// Blood Pressure Cuff

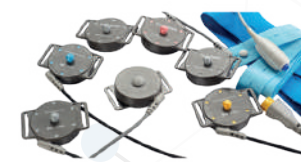

NST Prop Çeşitleri
// Fetal Monitor Probe



**Küçük Boy (22 cm)
Oksijen Hood Başlığı**
// Small (22 cm)
Oxygen Hood



Türkiyede üretiyor, Dünyaya satıyoruz...
We Produce In Turkey, We Sell To The World...



info@FARAMA.com.tr

